

## AVERAGE EVEN DIVISOR CORDIAL LABELING: A NEW VARIANT OF DIVISOR CORDIAL LABELING

V. SHARMA<sup>1</sup>, A. PARTHIBAN<sup>2\*</sup>, §

ABSTRACT. In the present paper, a new variant of divisor cordial labeling, named, an average even divisor cordial labeling, has been introduced. An average even divisor cordial labeling of a graph  $G^*$  on  $n$  vertices, is defined by a bijective function  $g^* : V(G^*) \rightarrow \{2, 4, 6, \dots, 2n\}$  such that each  $e = ab$  is assigned label 1 if  $2/\frac{g^*(a)+g^*(b)}{2}$ , otherwise 0; then the difference of edges having labels 1 and 0 should not exceed by 1. A graph is called an average even divisor cordial graph if it admits to average even divisor cordial labeling. In this article, various general results of high interest are explored.

Keywords: Graph labeling, average even divisor cordial labeling, square grid, Corona.

AMS Subject Classification: 05C78.

### 1. INTRODUCTION

Assignment of labels (mostly integers) to vertices or/and edges of a graph  $G(V, E)$ , under some restrictions is called a graph labeling. Graph labeling being the frontier between number theory and structure of graphs is the fastest growing area in the present world due to its application in many important fields like coding theory, circuit design, database management system, X-ray crystallography, radar and missile guidance, communication networks and network security.

In this article, all graphs considered are simple, finite, connected, and undirected. We refer to [3] and [5] respectively for various terms related to number theory and graph theory that are used and essential for understanding of this research article. More than 3000 research papers on different type of graph labeling can be found in [4] along with considerable bibliography. For definitions and other related literature we refer to [1] [4] and [10]. Cahit [2] introduced the theme of cordial labeling. After Cahit, various authors explored different variants of cordial labeling with a slight change in the cordial theme. The one among those is divisor cordial labeling [11]. To enrich the field further, a few variants of divisor cordial labeling namely square divisor cordial [9], cube divisor cordial

---

<sup>1</sup> Department of Mathematics, Lovely Professional University, Phagwara, 144 411, India.

e-mail: vishuup@gmail.com; ORCID: 0000-0003-1085-6542

<sup>2</sup> Mathematics Division, School of Advanced Sciences, Vellore Institute of Technology, Vellore, India.

e-mail: mathparthi@gmail.com; ORCID: 0000-0002-8375-4072.

\* Corresponding author.

§ Manuscript received: May 31, 2022; accepted: September 05, 2022.

TWMS Journal of Applied and Engineering Mathematics, Vol.14, No.3 © Işık University, Department of Mathematics, 2024; all rights reserved.

[6], sum divisor cordial [8], double divisor cordial [13] etc. are introduced and studied which motivated us to introduce the present variant named average even divisor cordial labeling. We use AEDCL and AEDCG respectively to denote average even double divisor cordial labeling and average even double divisor cordial graph.

**Definition 1.1.** *AEDCL of a graph  $H^*$  having node set  $V_{H^*}$  is a one-one, onto map  $h^*$  from  $V_{H^*}$  to  $\{2, 4, 6, \dots, 2|V_{H^*}|\}$  so that each edge  $u_1v_1$  is allocated the label 1, when  $2/\frac{h^*(u_1)+h^*(v_1)}{2}$  and 0 otherwise; then the modulus of difference of the count of edges having labels 1 and 0 is at the most 1. A graph is considered an AEDCG if it admits an AEDCL.*

**Note:** The terms node and vertex are interchangeable.

## 2. MAIN RESULTS

In this section, we explore some general results on AEDCL of graphs.

**Theorem 2.1.** *Let  $G^*$  admits AEDCL and is of even size then  $G^* \pm e$  also admits an AEDCL.*

*Proof.* Since  $G^*$  is an AEDCG of even size therefore  $e_f(0) = e_f(1)$ . Clearly, an addition or deletion of one edge will yield either  $e_f(0) = e_f(1) + 1$  or  $e_f(1) = e_f(0) + 1$  which in turn justifies that  $|e_f(0) - e_f(1)| \leq 1$ . □

**Theorem 2.2.** *Let  $G^*$  be an AEDCG of odd size then  $G^* - e$  admits an AEDCL.*

*Proof.* Given  $G^*$  a AEDCG of odd size. Therefore, either  $e_f(0) = e_f(1) + 1$  or  $e_f(1) = e_f(0) + 1$ . Suppose  $e_f(0) = e_f(1) + 1$ . Removing an edge having label 0 yields  $|e_f(0) - e_f(1)| \leq 1$ . Similarly, if  $e_f(1) = e_f(0) + 1$ , then removing any edge having label 1 results in AEDCG again. □

**Remark 2.1.** *On similar lines of proof we can observe that above theorem also holds good for  $G^* + e$ .*

**Theorem 2.3.**  *$K_n$  does not admit AEDCL for  $n \geq 4$ .*

*Proof.* For  $K_2$  and  $K_3$ , result is obvious.

For  $n \geq 4$ , let  $\{u_i : 1 \leq i \leq n\}$  denotes the node set of  $K_n$ . We define  $f : V(K_n) \rightarrow \{2, 4, 6, \dots, 2n\}$  by taking  $f(u_i) = 2i; 1 \leq i \leq n$ . Now we have two cases.

Case (i): When  $n$  is even.

Observing the labeling pattern, we find that  $e_f(1) = e_f(0) - \frac{n}{2}$ , which implies that  $|e_f(0) - e_f(1)| = \frac{n}{2}$  or  $|e_f(0) - e_f(1)| \geq 2$ .

Case (ii): When  $n$  is odd.

Observing  $f$ , we find that  $e_f(1) = e_f(0) - \lfloor \frac{n}{2} \rfloor$  which shows that  $|e_f(0) - e_f(1)| = \lfloor \frac{n}{2} \rfloor$  or  $|e_f(0) - e_f(1)| \geq 2$ .

Thus, in both the cases  $K_n, n \geq 4$  is not an AEDCL. □

**Observation 1:** For a graph  $G$  admitting AEDCL, its supergraph need not admit AEDCL as complete graph is always a supergraph of a given graph with same number of nodes.

**Observation 2:** For a graph  $G$  admitting an AEDCL, its subgraph need not admit AEDCL. For the explanation, we consider  $C_{10}$  and  $W_{10}$ .  $C_{10}$  is a subgraph of  $W_{10}$ . Further,  $W_{10}$  admits an AEDCL but  $C_{10}$  does not.

**Theorem 2.4.**  *$K_{m,n}$  admits an AEDCL.*

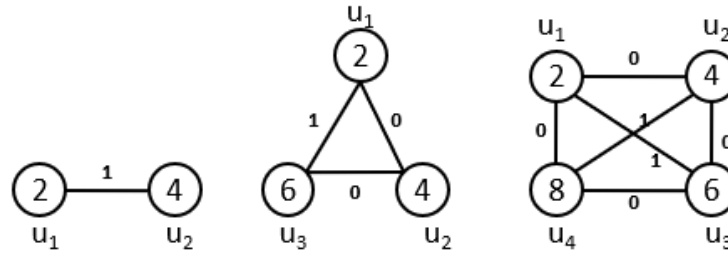

FIGURE 1.  $K_2$  are  $K_3$  admitting AEDCL and  $K_4$  is not

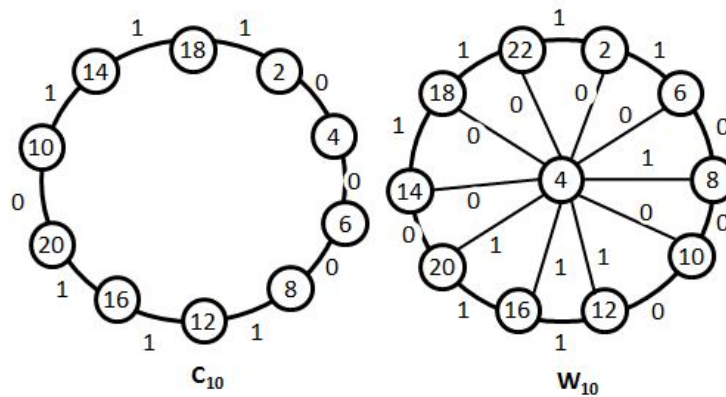

FIGURE 2.  $C_{10}$  is not admitting AEDCL, whereas  $W_{10}$  is admitting

*Proof.* Let  $V(K_{m,n}) = V_1 \cup V_2$ , where  $V_1 = \{x_1, x_2, \dots, x_m\}$  and  $V_2 = \{y_1, y_2, \dots, y_n\}$ . Vertex labeling is done by considering a bijective function  $f^* : V(K_{m,n}) \rightarrow \{2, 4, 6, \dots, 2m + 2n\}$  as given here. Let  $f^*(x_1) = 2, f^*(x_i) = f^*(x_{i-1}) + 2; 2 \leq i \leq m,$   
 $f^*(y_1) = f^*(x_m) + 2, f^*(y_i) = f^*(y_{i-1}) + 2; 2 \leq i \leq n.$   
 Observe that when  $mn$  is even, then  $e_{f^*}(0) = e_{f^*}(1) = \frac{mn}{2}$ , and when  $mn$  is odd then  $|e_{f^*}(0) - e_{f^*}(1)| = 1$ , which shows that  $K_{m,n}$  admits an AEDCL.  $\square$

**Definition 2.1.** [12] A full binary tree is a binary tree in which each internal vertex has exactly 2 children.

**Theorem 2.5.** Full  $n -$ ary tree admits an AEDCL, where  $n = 2k, k \in \mathbf{N}$ .

*Proof.* Let  $T$  denotes the full  $n -$ ary tree. Clearly, zero<sup>th</sup> level has one node, first level has  $n$  nodes, second level has  $n^2$  nodes, third level has  $n^3$  nodes and  $m^{\text{th}}$  level has  $n^m$  nodes. Define  $f : V(T) \rightarrow \{2, 4, 6, \dots, 2(n^m + n^{m-1} + n^{m-2} + \dots + n + 1)\}$  such that the node of zero<sup>th</sup> level be labeled with 2. For first level, assign the labels, beginning from leftmost node and proceeding to right, simultaneously from the available labels. By doing so, the last node of the first level is labeled with  $2n + 2$ . Similarly, for second level, the last node has label  $2(2n + 2) + 2$ . Proceeding this way, we find that the last(rightmost) node in  $m^{\text{th}}$  level has  $2n^m + 2n^{m-1} + 2n^{m-2} + \dots + 2n + 2$  label. Note that in every level,  $e_f(0) = e_f(1)$  which means that  $|e_f(0) - e_f(1)| = 0$  and hence  $T$  admits an AEDCL.  $\square$

**Theorem 2.6.** All trees are AEDCG.

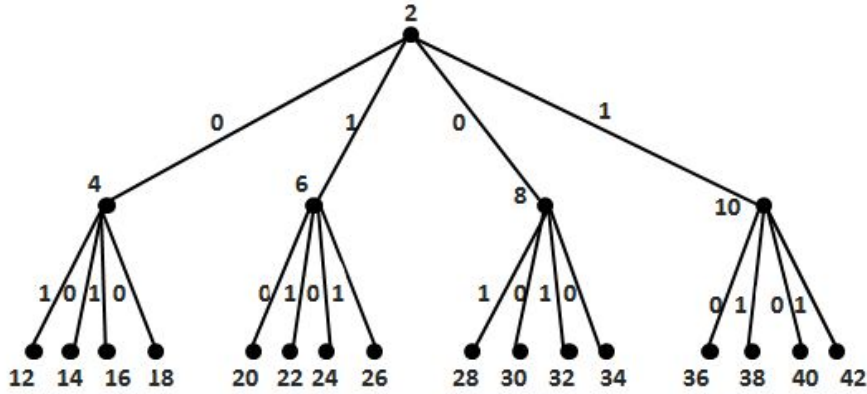

FIGURE 3. AEDCL of full 4 – ary tree having 2 levels

*Proof.* Let  $T_k$  denotes a tree with  $k$  edges. We show that  $T_k$  is an AEDCG. We prove the theorem by principle of mathematical induction. Suppose  $k = 2$ , the  $T_2$  is a path on 3 nodes which is an AEDCG. Now suppose the result is true for  $k - 1$ , i.e;  $T_{k-1}$  is an AEDCG. We show that  $T_k$  is an AEDCG. Adding one edge in  $T_{k-1}$  also admits AEDCL (by Theorem 2.1), we see that  $T_k$  is an AEDCG, which completes the induction. Hence  $T_k$  is an AEDCG.  $\square$

**Lemma 2.1.**  $P_n$  admits an AEDCL.

*Proof.* Let  $V(P_n) = \{p_i : 1 \leq i \leq n\}$  and  $E(P_n) = \{p_i p_{i+1} : 1 \leq i \leq n - 1\}$ . Consider a bijective function  $g^* : V(P_n) \rightarrow \{2, 4, 6, \dots, 2n\}$  defined as given.

Case(i). When  $n$  is even.

Let  $g^*(p_1) = 2, g^*(p_i) = g^*(p_{i-1}) + 2; 2 \leq i \leq \frac{n}{2}, g^*(p_{\frac{n}{2}+1}) = g^*(p_{\frac{n}{2}}) + 4.$

Now we have two subcases.

Subcase(i). When  $\frac{n}{2}$  is even.

Fix  $g^*(p_i) = g^*(p_{i-1}) + 4; \frac{n}{2} + 2 \leq i \leq \frac{n}{2} + \frac{n}{4},$

$g^*(p_{\frac{n}{2}+\frac{n}{4}+1}) = g^*(p_{\frac{n}{2}}) + 2, g^*(p_i) = g^*(p_{i-1}) + 4; \frac{n}{2} + \frac{n}{4} + 2 \leq i \leq n.$  One can see that  $|e_{g^*}(0) - e_{g^*}(1)| \leq 1.$

Subcase(ii). When  $\frac{n}{2}$  is odd.

Put  $g^*(p_i) = g^*(p_{i-1}) + 4; \frac{n}{2} + 2 \leq i \leq \frac{n}{2} + \lfloor \frac{n}{4} \rfloor,$

$g^*(p_{\frac{n}{2}+\lfloor \frac{n}{4} \rfloor+1}) = g^*(p_{\frac{n}{2}}) + 2, g^*(p_i) = g^*(p_{i-1}) + 4; \frac{n}{2} + \lfloor \frac{n}{4} \rfloor + 2 \leq i \leq n.$

One can see that  $|e_{g^*}(0) - e_{g^*}(1)| \leq 1.$

Case(ii). When  $n$  is odd.

Let  $g^*(p_1) = 2, g^*(p_i) = g^*(p_{i-1}) + 2; 2 \leq i \leq \lfloor \frac{n}{2} \rfloor,$

$g^*(p_{\lfloor \frac{n}{2} \rfloor+1}) = g^*(p_{\lfloor \frac{n}{2} \rfloor}) + 4, g^*(p_i) = g^*(p_{i-1}) + 4; \lfloor \frac{n}{2} \rfloor + 2 \leq i \leq k < n,$  where  $g^*(p_k) \leq 2n.$

Next,  $g^*(p_{k+1}) = g^*(p_{\lfloor \frac{n}{2} \rfloor}) + 2, g^*(p_{k+2}) = g^*(p_{k+1}) + 4, g^*(p_i) = g^*(p_{i-1}) + 4; k + 3 \leq i \leq n.$

An easy check shows that  $|e_{g^*}(0) - e_{g^*}(1)| \leq 1. \square$

**Lemma 2.2.**  $C_n$  admits an AEDCL for all  $n$  except when  $n \equiv 2 \pmod{4}.$

*Proof.* Let  $V(C_n) = \{c_i : 1 \leq i \leq n\}$  and  $E(C_n) = \{c_i c_{i+1} : 1 \leq i \leq n - 1\} \cup \{c_n c_1\}.$  Consider a bijective function  $g^* : V(C_n) \rightarrow \{2, 4, 6, \dots, 2n\}$  defined as given.

Case(i). When  $n$  is odd.

Fix  $g^*(c_1) = 2, g^*(c_i) = g^*(c_{i-1}) + 2; 2 \leq i \leq \lfloor \frac{n}{2} \rfloor, g^*(c_{\lfloor \frac{n}{2} \rfloor+1}) = g^*(c_{\lfloor \frac{n}{2} \rfloor}) + 4, g^*(c_i) = g^*(c_{i-1}) + 4; \lfloor \frac{n}{2} \rfloor + 2 \leq i \leq k < n,$  where  $g^*(c_k) \leq 2n.$  Next,  $g^*(c_{k+1}) = g^*(c_{\lfloor \frac{n}{2} \rfloor}) + 2,$

$g^*(c_{k+2}) = g^*(c_{k+1}) + 4$ ,  $g^*(c_i) = g^*(c_{i-1}) + 4$ ;  $k + 3 \leq i \leq n$ . One can verify that  $|e_{g^*}(0) - e_{g^*}(1)| = 1$ .

Case (ii). When  $n \equiv 4 \pmod{4}$ .

Let  $g^*(c_1) = 2$ ,  $g^*(c_i) = g^*(c_{i-1}) + 2$ ;  $2 \leq i \leq \frac{n}{2}$ ,  $g^*(c_{\frac{n}{2}+1}) = g^*(c_{\frac{n}{2}}) + 4$ ,  $g^*(c_i) = g^*(c_{i-1})$ ;  $\frac{n}{2} + 2 \leq i \leq \frac{n}{2} + \frac{n}{4}$ ,  $g^*(c_{\frac{n}{2}+\frac{n}{4}+1}) = g^*(c_{\frac{n}{2}}) + 2$ ,  $g^*(c_i) = g^*(c_{i-1}) + 4$ ;  $\frac{n}{2} + \frac{n}{4} + 2 \leq i \leq n$ . One can see that  $|e_{g^*}(0) - e_{g^*}(1)| = 1$ .

Case(iii). When  $n \equiv 2 \pmod{4}$ .

Here, in this case, either  $e_{g^*}(0) = e_{g^*}(1) + 2$  or  $e_{g^*}(1) = e_{g^*}(0) + 2$ , which means that  $g^*$  is not AEDCL. □

**Lemma 2.3.**  $W_n$  admits an AEDCL,  $\forall n \neq 4k + 3$ ,  $k \in \mathbb{N}$ .

*Proof.* Let  $V(W_n) = \{x_0, x_i : 1 \leq i \leq n\}$  and  $E(W_n) = \{x_0x_i, x_ix_{i+1} : 1 \leq i \leq n-1\} \cup \{x_nx_1\}$ . Consider a bijective function  $g^* : V(W_n) \rightarrow \{2, 4, 6, \dots, 2n+2\}$  defined as given.

Case(i): When  $n = 4k$

Put  $g^*(x_0) = 2$ ,  $g^*(x_1) = 4$ ,  $g^*(x_i) = g^*(x_{i-1}) + 2$ ;  $2 \leq i \leq \frac{n}{2} - 1$ ,  $g^*(x_{\frac{n}{2}}) = g^*(x_{\frac{n}{2}-1}) + 4$ ,  $g^*(x_i) = g^*(x_{i-1}) + 4$ ;  $\frac{n}{2} + 1 \leq i \leq k < n$ , such that  $g^*(x_k) \leq 2n+2$ . Next,  $g^*(x_{k+1}) = g^*(x_{\frac{n}{2}-1}) + 2$ ,  $g^*(x_i) = g^*(x_{i-1}) + 4$ ;  $k+2 \leq i \leq n$ . One can easily verify that  $|e_{g^*}(0) - e_{g^*}(1)| = 0$ .

Case(ii): When  $n = 4k + 2$ .

Let  $g^*(x_0) = 4$ ,  $g^*(x_1) = 2$ ,  $g^*(x_2) = 6$ ,  $g^*(x_i) = g^*(x_{i-1}) + 2$ ;  $3 \leq i \leq \frac{n}{2}$ ,  $g^*(x_{\frac{n}{2}+1}) = g^*(x_{\frac{n}{2}}) + 4$ ,  $g^*(x_i) = g^*(x_{i-1}) + 4$ ;  $\frac{n}{2} + 2 \leq i \leq k < n$ , such that  $g^*(x_k) \leq 2n+2$ . Next, fix  $g^*(x_{k+1}) = g^*(x_{\frac{n}{2}}) + 2$ ,  $g^*(x_i) = g^*(x_{i-1}) + 4$ ;  $k+2 \leq i \leq n$ . In this case also,  $|e_{g^*}(0) - e_{g^*}(1)| = 0$ .

Case(iii): When  $n = 4k + 1$ .

Put  $g^*(x_0) = 2$ ,  $g^*(x_1) = 4$ ,  $g^*(x_i) = g^*(x_{i-1}) + 2$ ;  $2 \leq i \leq \frac{n-1}{2}$ ,  $g^*(x_{\frac{n+1}{2}}) = g^*(x_{\frac{n-1}{2}}) + 4$ ,  $g^*(x_i) = g^*(x_{i-1}) + 4$ ;  $\frac{n+1}{2} + 1 \leq i \leq k < n$ , such that  $g^*(x_k) \leq 2n+2$ . Next,  $g^*(x_{k+1}) = g^*(x_{\frac{n-1}{2}}) + 2$ ,  $g^*(x_i) = g^*(x_{i-1}) + 4$ ;  $k+2 \leq i \leq n$ .

One can observe that  $|e_{g^*}(0) - e_{g^*}(1)| = 0$ .

Case(iv): When  $n = 4k + 3$ .

Here, in this case, either  $e_{g^*}(0) = e_{g^*}(1) + 2$  or  $e_{g^*}(1) = e_{g^*}(0) + 2$ , which means that  $g^*$  is not AEDCL. □

**Definition 2.2.** [1] If  $H^*$  is a graph of order  $r$ , then the corona product of  $H^*$  with another graph  $K^*$ , represented by  $H^* \odot K^*$  is a graph acquired by considering one copy of  $H^*$  and  $r$  copies of  $K^*$  thereby connecting the  $r^{\text{th}}$  node of  $H^*$  by an edge to each node in the  $r^{\text{th}}$  copy of  $K^*$ .

**Theorem 2.7.** Let  $G^*(p, q)$  be an AEDCG then  $G^* \odot \bar{K}_t$  admits AEDCL for  $t \equiv 0 \pmod{2}$ .

*Proof.* Given  $G^*(p, q)$  is an AEDCG with  $V(G^*) = \{u_i^* : 1 \leq i \leq p\}$ , therefore there exists vertex labeling  $g : V(G^*) \rightarrow \{2, 4, 6, \dots, 2p\}$  on  $G^*$  such that  $|e_g(0) - e_g(1)| \leq 1$ . Given  $t \equiv 0 \pmod{2}$ , we fix  $t = 2m$ . Consider  $G^* \odot \bar{K}_{2m}$  with  $V(G^* \odot \bar{K}_{2m}) = V(G^*) \cup \{k_j^{(i)} : 1 \leq i \leq p, 1 \leq j \leq 2m\}$  and  $E(G^* \odot \bar{K}_{2m}) = E(G^*) \cup \{u_i^*k_j^{(i)} : 1 \leq i \leq p, 1 \leq j \leq 2m\}$ . Consider bijective function  $f : V(G^* \odot \bar{K}_{2m}) \rightarrow \{2, 4, 6, \dots, 2p, 2p+2, \dots, 2p+2p(2m)\}$  defined as here. Let  $f(u_i^*) = g(u_i^*)$ ;  $1 \leq i \leq p$ . We are left with  $\{2p+2, 2p+4, \dots, 2p+2p(2m)\}$  labels. Start assigning these labels simultaneously, beginning with first copy of  $\bar{K}_{2m}$  that

is attached to  $u_1^*$  and then slowly proceeding to the right most copy, i.e; the one attached with  $u_p^*$ . Here are the following observations:

- (i) When  $q$  is even, then  $e_g(0) = e_g(1)$  and pendant vertices that appear at each  $u_i^*$  yields equal number of edges with labels 1 and 0. Thus,  $e_f(0) = e_f(1)$ .
- (ii) When  $q$  is odd, then either  $e_g(0) = e_g(1) + 1$  or  $e_g(1) = e_g(0) + 1$ . But pendant edges at each  $u_i^*$  yield equal number of edges with 1 and 0 which implies that  $|e_g(0) - e_g(1)| = 1$ , which proves that  $G^* \odot \bar{K}_{2m}$  is an AEDCG. □

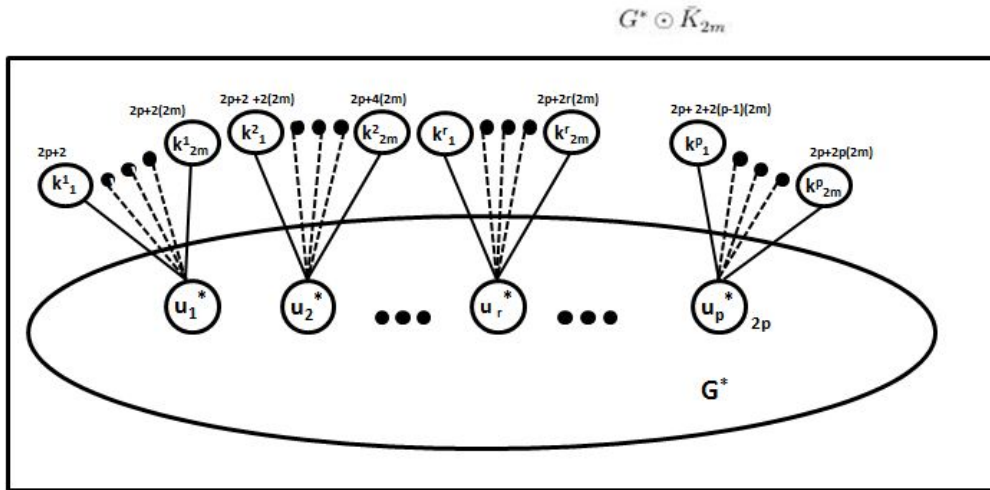

FIGURE 4. AEDCL of  $G^* \odot \bar{K}_{2m}$

**Corollary 2.1.**  $P_n \odot \bar{K}_{2m}$  is an AEDCG.

*Proof.* The proof follows directly from Lemma 2.1 and Theorem 2.7. □

**Corollary 2.2.**  $C_n \odot \bar{K}_{2m}$ ,  $n \neq 4k + 2$ ,  $k \in \mathbf{N}$  is an AEDCG.

*Proof.* The proof follows directly from Lemma 2.2 and Theorem 2.7. □

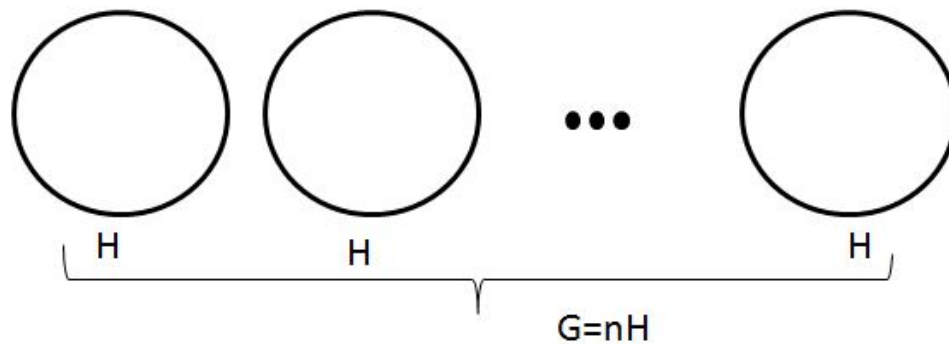

FIGURE 5. Disjoint union of  $n$  copies of  $H$

**Theorem 2.8.** The disjoint union of  $n$  – copies of  $H$  admits an AEDCL, where  $H$  is an AEDCG of even size.

*Proof.* Let  $H(p, q)$  admits an AEDCG with vertex labeling  $f$ . Let  $V(H) = \{v_1, v_2, \dots, v_p\}$ . Let  $G = nH$  as shown in Figure 5 with  $V(G) = \{v_j^i : 1 \leq j \leq p; 1 \leq i \leq n\}$ . Define a function  $f' : V(G) \rightarrow \{2, 4, \dots, 2np\}$  as follows:

$$\begin{aligned} f'(v_j^1) &= f(v_j^1); 1 \leq j \leq p; \\ f'(v_j^2) &= f'(v_j^1) + 2p; 1 \leq j \leq p; \\ f'(v_j^3) &= f'(v_j^2) + 2p; 2 \leq j \leq p; \end{aligned}$$

Proceeding this way, we have  $f'(v_j^n) = f'(v_j^{n-1}) + 2p; 2 \leq j \leq p;$

Now, one can easily check that  $e_{f'}(0) = e_{f'}(1)$ , which establishes that  $G$  is an AEDCG.  $\square$

**Corollary 2.3.** *Let  $G$  be an AEDCG of even size and  $G^*$  be a copy of  $G$ . Then  $G \cup G^*$  is also an AEDCG.*

*Proof.* Since  $G$ , with  $V(G) = \{u_1, u_2, \dots, u_n\}$  is an AEDCG, with labeling  $f$ , and is of even size, therefore  $e_f(0) = e_f(1)$ . Let  $G^*$  with  $V(G^*) = \{u'_1, u'_2, \dots, u'_n\}$  be a copy of  $G$ . Let  $H = G \cup G^*$ , we define labeling  $h$  on  $V(H)$  by taking  $h(u_i) = f(u_i); 1 \leq i \leq n$  and  $h(u'_i) = h(u_i) + 2n; 1 \leq i \leq n$ . This way,  $e_h(0) = e_h(1)$ , hence  $G \cup G^*$  is AEDCG.  $\square$

**Theorem 2.9.** *Let  $G(p, q)$  be an AEDCG and is of even size. Then  $G + G$  is also an AEDCG.*

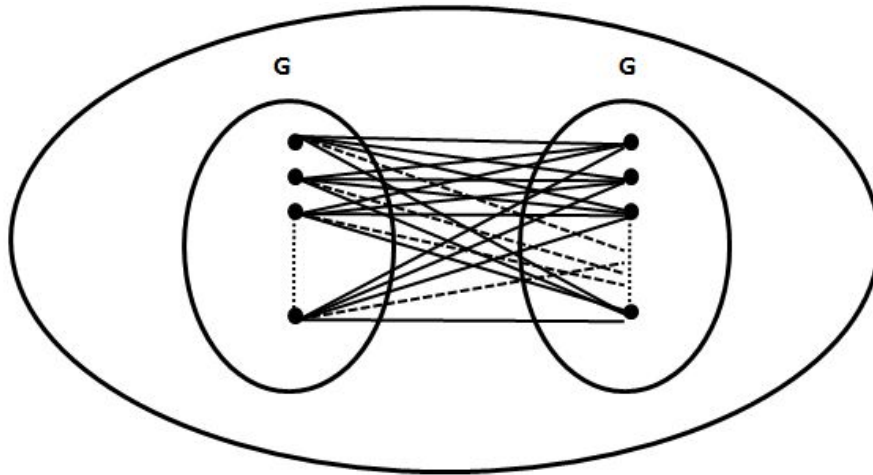

FIGURE 6. AEDCL of  $G + G$

*Proof.* The proof follows from Theorem 2.4 and Corollary 2.3.  $\square$

**Theorem 2.10.** *Ladder graph  $L_n = P_n \times P_2$  is an AEDCG.*

*Proof.* Let  $V(L_n) = \{u_i, v_i : 1 \leq i \leq n\}$  and  $E(L_n) = \{u_i u_{i+1} : 1 \leq i \leq n - 1\} \cup \{v_i v_{i+1} : 1 \leq i \leq n - 1\} \cup \{u_i v_i : 1 \leq i \leq n\}$ . Here, the cardinality of vertex set and edge set is  $2n$  and  $3n - 2$ , respectively. Vertex labeling is performed by considering a bijective function  $f : V(L_n) \rightarrow \{2, 4, 6, \dots, 4n\}$  defined under the following cases.

Case (i). When  $n = 4k, k \in \mathbf{N}$ .

Let  $f(u_1) = 2, f(u_i) = f(u_{i-1}) + 2; 2 \leq i \leq n - 1, f(u_n) = f(u_{n-1}) + 4, f(v_1) = 4n - 2, f(v_i) = f(v_{i-1}) - 4; 2 \leq i \leq \frac{n}{2} - 1, f(v_{\frac{n}{2}}) = 4n, f(v_i) = f(v_{i-1}) - 4; \frac{n}{2} + 1 \leq i \leq n$ . We can see that  $e_f(0) = e_f(1)$ .

Case (ii). When  $n = 4k - 1, k \in \mathbf{N}$ .

Let  $f(u_1) = 2, f(u_i) = f(u_{i-1}) + 2; 2 \leq i \leq n, f(v_1) = 4n - 2, f(v_i) = f(v_{i-1}) - 4; 2 \leq i \leq \lfloor \frac{n}{2} \rfloor, f(v_{\lceil \frac{n}{2} \rceil}) = 4n, f(v_i) = f(v_{i-1}) - 4; \lceil \frac{n}{2} \rceil + 1 \leq i \leq n$ . One can easily verify that  $e_f(0) = \frac{3n-1}{2}$  and  $e_f(1) = \frac{3n-3}{2}$ .

Case (iii). When  $n = 4k - 3, k \in \mathbf{N} - \{1\}$ .

Let  $f(u_1) = 2, f(u_i) = f(u_{i-1}) + 2; 2 \leq i \leq n - 2, f(u_{n-1}) = f(u_{n-2}) + 4, f(u_n) = f(u_{n-1}) + 4, f(v_1) = 4n - 2, f(v_i) = f(v_{i-1}) - 4; 2 \leq i \leq \lfloor \frac{n}{2} \rfloor - 1, f(v_{\lfloor \frac{n}{2} \rfloor}) = 4n, f(v_i) = f(v_{i-1}) - 4; \lfloor \frac{n}{2} \rfloor + 1 \leq i \leq n$ . It can be verified that  $e_f(0) = \frac{3n-3}{2}$  and  $e_f(1) = \frac{3n-1}{2}$ .

Case (iv): When  $n = 4k - 2, k \in \mathbf{N} - \{1\}$ .

Let  $f(u_1) = 2, f(u_i) = f(u_{i-1}) + 2; 2 \leq i \leq n - 2, f(u_{n-1}) = f(u_{n-2}) + 4, f(u_n) = f(u_{n-1}) + 4, f(v_1) = 4n, f(v_i) = f(v_{i-1}) - 4; 2 \leq i \leq \frac{n}{2} - 1, f(v_{\frac{n}{2}}) = 4n - 2, f(v_i) = f(v_{i-1}) - 4; \frac{n}{2} + 1 \leq i \leq n$ . Here  $e_f(0) = e_f(1)$ .

We observe in all the cases that  $|e_f(0) - e_f(1)| \leq 1$ , which proves that  $L_n$  is an AEDCG. We observe in all the cases that  $|e_f(0) - e_f(1)| \leq 1$ , which proves that  $L_n$  is an AEDCG.  $\square$

**Theorem 2.11.** *Triangular ladder  $TL_n$  is an AEDCG.*

*Proof.* Let  $V(TL_n) = \{u_i, v_i : 1 \leq i \leq n\}$  and  $E(TL_n) = \{u_i u_{i+1} : 1 \leq i \leq n-1\} \cup \{v_i v_{i+1} : 1 \leq i \leq n-1\} \cup \{u_i v_i : 1 \leq i \leq n\} \cup \{v_i u_{i+1} : 1 \leq i \leq n-1\}$ . Vertex labeling is performed by considering a bijective function  $f : V(TL_n) \rightarrow \{2, 4, 6, \dots, 4n\}$  defined by fixing  $f(u_1) = 2, f(u_i) = f(u_{i-1}) + 4; 2 \leq i \leq n, f(v_1) = 4, f(v_i) = f(v_{i-1}) + 4; 2 \leq i \leq n$ . It is noted here that  $|e_f(0) - e_f(1)| \leq 1$  which implies that  $TL_n$  is an AEDCG.  $\square$

**Theorem 2.12.** *Square grid  $P_n \times P_n$  admits AEDCL.*

*Proof.* Let  $V(P_n \times P_n) = \{v_i^{(j)} : 1 \leq i \leq n, 1 \leq j \leq n\}$  represents the node set of  $P_n \times P_n$ , where  $v_i^{(j)}$  represents the  $i^{th}$  node of  $j^{th}$  copy. Clearly,  $|V(P_n \times P_n)| = n^2$  and  $|E(P_n \times P_n)| = 2n^2 - 2n$ . Vertex labeling is performed by considering a bijective function  $f : V(P_n \times P_n) \rightarrow \{2, 4, 6, \dots, 2n^2\}$  defined by the following cases.

Case (i): When  $n$  is even.

Let  $f(v_1^{(1)}) = 2, f(v_i^{(1)}) = f(v_{i-1}^{(1)}) + 4; 2 \leq i \leq n,$

$f(v_1^{(2)}) = 4, f(v_i^{(2)}) = f(v_{i-1}^{(2)}) + 4; 2 \leq i \leq n,$

$f(v_1^{(3)}) = f(v_n^{(1)}) + 4, f(v_i^{(3)}) = f(v_{i-1}^{(3)}) + 4; 2 \leq i \leq n,$

$f(v_1^{(4)}) = f(v_n^{(2)}) + 4, f(v_i^{(4)}) = f(v_{i-1}^{(4)}) + 4; 2 \leq i \leq n,$

..., ..., ...,

..., ..., ...,

$f(v_1^{(n-1)}) = f(v_n^{(n-3)}) + 4, f(v_i^{(n-1)}) = f(v_{i-1}^{(n-1)}) + 4; 2 \leq i \leq n$

$f(v_1^{(n)}) = f(v_n^{(n-2)}) + 4, f(v_i^{(n)}) = f(v_{i-1}^{(n)}) + 4; 2 \leq i \leq n.$

It is noted here that  $e_f(0) = e_f(1) = n^2 - n$  which implies that  $P_n \times P_n$  is an AEDCG.

Case (ii): When  $n$  is odd.

For first  $n - 1$  steps, follow the pattern of case (i). For last row, proceed with the remaining labels as per Lemma 2.1.

In this case,  $|e_f(0) - e_f(1)| \leq 1$  which establishes that  $P_n \times P_n$  is AEDCG.  $\square$

**Definition 2.3.** [7] *The stack  $S_k$  of books is a union of  $k -$  copies of triangular book  $K_{1,1,5}$  denoted by  $B_5$ , joined in a way that their spines form a path.*

**Lemma 2.4.** *Triangular book graph  $K_{1,1,n}$  admits an AEDCG.*



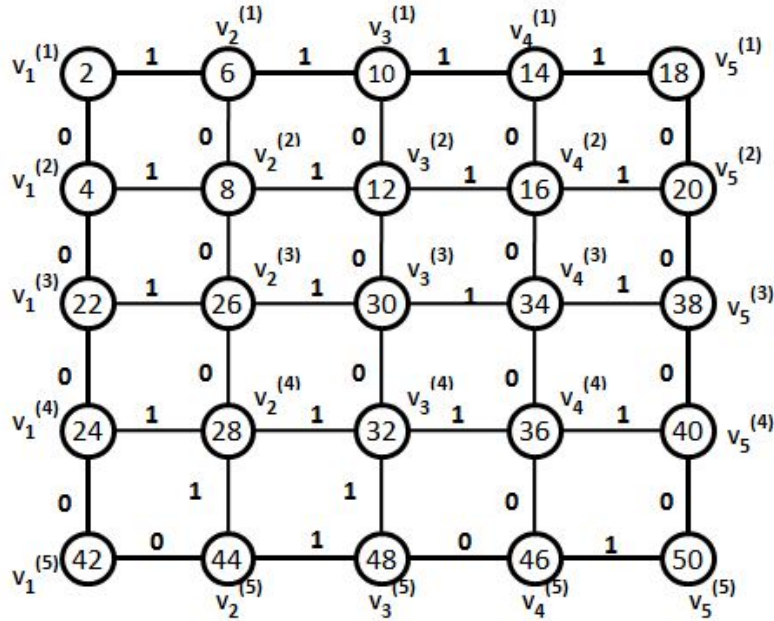

FIGURE 7. AEDCL of  $P_5 \times P_5$

*Proof.* For labeling of generalised triangular book graph with  $V(K_{1,1,n}) = \{x_0, x'_0, x_1, x_2, \dots, x_n\}$ , we define a bijective function  $f : V(K_{1,1,n}) \rightarrow \{2, 4, \dots, 2n + 4\}$  in such a way that spine nodes, namely,  $x_0$  and  $x'_0$  be fixed 2 and 4 respectively and allocate the unused labels to remaining nodes in any fashion.  $\square$

**Theorem 2.13.**  $S_k$  admits an AEDCG.

*Proof.* Let  $V(S_k) = V(P_{k+1}) \cup \{v_i^{(j)} : 1 \leq i \leq 5, 1 \leq j \leq k\}$  and  $E(S_k) = E(P_{k+1}) \cup \{p_j v_i^{(j)}, p_{j+1} v_i^{(j)} : 1 \leq i \leq 5, 1 \leq j \leq k\}$  represents respectively the node set and edge set of  $S_k$ , where  $v_i^{(j)}$  represents the  $i^{th}$  node of  $j^{th}$  copy. Clearly,  $|V(S_k)| = 6k + 1$  and  $|E(S_k)| = 11k$ . Vertex labeling is performed by considering a bijective function  $f : V(S_k) \rightarrow \{2, 4, 6, \dots, 2(6k + 1)\}$ . First label the  $k + 1$  nodes of  $P_{k+1}$  by using Lemma 2.1. This way  $\{2, 4, \dots, 2k + 2\}$  labels are exhausted. Now start assigning the remaining labels simultaneously, beginning with the first node of degree 2 of first copy of  $B_5$  and proceeding to the last node of last copy. Clearly,  $|e_f(0) - e_f(1)| \leq 1$  which establishes that  $S_k$  admits an AEDCL.  $\square$

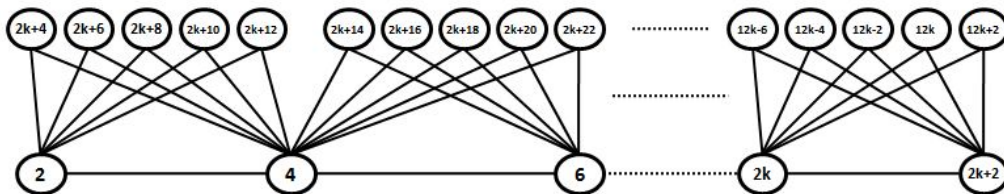

FIGURE 8. AEDCL of  $S_k$

**Theorem 2.14.** *Let  $G$  and  $H$  be two isomorphic graphs. If  $G$  admits an AEDCL then  $H$  also does.*

*Proof.* Let  $G$  and  $H$  be two graphs with isomorphism  $f$  from  $V(G) = \{u_1, u_2, \dots, u_p\}$  to  $V(H) = \{v_1, v_2, \dots, v_p\}$ . Let  $g^*$  be an AEDCL of  $G$ . If  $e = u_i u_j \in E(G)$  implies  $f(e = u_i u_j) \in E(H)$  for any  $i, j$ . Let  $g^*(u_i) = r, g^*(u_j) = s$  for some  $r, s \in \{2, 4, \dots, 2p\}$  such that  $|e_{g^*}(0) - e_{g^*}(1)| \leq 1$ . Now define  $h : V(H) \rightarrow \{2, 4, \dots, 2p\}$  such that  $h(f(u_i)) = g^*(u_i); 1 \leq i \leq p$ . Then  $h$  is desired AEDCL of  $H$  as  $|e_{g^*}(0) - e_{g^*}(1)| = |e_h(0) - e_h(1)| \leq 1$ .  $\square$

### 3. CONCLUSION

In this paper a new variant of divisor cordial labeling, named, an average even divisor cordial labeling has been investigated for various classes of graphs. We have established that complete graphs, complete bipartite graphs, square grid and full  $n - ary$  tree are AEDCG.

### REFERENCES

- [1] Bosmia, M. I. and Kanani, K.K., (2016), Divisor Cordial Labeling in the Context of Corona Product, 9th National Level Science Symposium organised by Christ College, Rajkot and sponsored by GUJCOST, Gandhinagar, pp. 178-182.
- [2] Cahit, I., (1987), Cordial graphs: A Weaker Version of Graceful and Harmonious Graphs, *Ars Combinatoria*, 23, pp. 201-207.
- [3] David, B., (1980), *Elementary Number Theory*, Wm.C.Brown Company Publishers, second edition.
- [4] Gallain, J. A., (2009), A Dynamic Survey of Graph Labeling, *Electronic Journal of Combinatorics*, # DS6.
- [5] Hararay, F.,(1972), *Graph Theory*, Addison Wesley Reading.
- [6] Kanani, K. K. and Bosmia, M.I., (2015), On Cube Divisor Cordial Graphs, *International Journal of Mathematics and Computer Applications Research*, 5, pp. 117-128.
- [7] Laison, J. D., Starr, C. and Walker, A., (2013), Finite Prime Distance Graphs and 2-Odd Graphs, *Discrete Mathematics*, 313, pp. 2281-2291.
- [8] Lourdusamy, A. and Patrick, F., (2016), Sum Divisor Cordial Graphs, *Proyecciones*, 35, pp. 119-136.
- [9] Murugesan, S., Jayaraman, D. and Shiama, A., (2013), Square Divisor Cordial Graphs, *International Journal of Computer Applications*, 64, pp. 1-4.
- [10] Parthiban, A. and Sharma, V., (2020), A Comprehensive Survey on Prime Cordial and Divisor Cordial Labeling of Graphs, *Journal of Physics: Conference Series*, 1531(2020)012074 doi: 10.1088/1742-6596/1531/1/012074.
- [11] Varatharajan, R., Navaneethakrishnan, S. and Nagarajan, K., (2011), Divisor Cordial Graphs, *International Journal of Mathematical Combinatorics*, 4, pp. 15-25.
- [12] Varatharajan, R., Navaneethakrishnan, S. and Nagarajan, K., (2012), Special Classes of Divisor Cordial Graphs, *International Mathematical Forum*, 7, pp. 1737-1749.
- [13] Sharma, V. and Parthiban, A., (2022), Double Divisor Cordial Labeling of Graphs, *Journal of Physics: Conference Series*, 2267 (2022) 012026. doi:10.1088/1742-6596/2267/1/012026.



**Vishally Sharma** is currently employed as an Assistant Professor of Mathematics in the Higher Education Department, Govt. of J&K, India. She is pursuing her Ph.D. at the Department of Mathematics, School of Chemical Engineering and Physical Sciences, LPU, Punjab, India. She received her Post-graduation and Master of Philosophy from the University of Jammu. She is doing her research in the area of graph labeling under the supervision of Dr. A. Parthiban.

---

**Dr. A. Parthiban** for the photography and short autobiography, see TWMS J. App. and Eng. Math. V.14, N.2.

---